



# **PRE-DELIVERY INSPECTION AND SCHEDULED MAINTENANCE SERVICES**

PRE-DELIVERY INSPECTION ..... 0- 2  
SCHEDULED MAINTENANCE SERVICES ... 0-13

## PRE-DELIVERY INSPECTION TABLE

### EXTERIOR

- Inspect glass, exterior bright metal and paint for damage or rust.
- Check door operation and alignment.
- Check all weather strips for damage and detachment.
- Install outside rearview mirror.
- Tighten lug nuts to specifications.
- Adjust tire pressures to specifications.
- Install wheel rings or covers (if equipped).
- Check operation of rear glass hatch.
- Check operation of hood release and lock.
- Check operation of fuel lid opener.
- Check operation of all lights and retractable headlight mechanism (including warning and indicator lights).
- Check operation of horn, windshield wipers and washers (including rear window wiper and washer).
- Check operation and fit of windows (including power windows).
- Check heater, defroster and air conditioner (if equipped) air flow when the various modes are selected.
- Inspect upholstery and interior finish.

### UNDER HOOD-ENGINE OFF

- Inspect fuel, coolant and hydraulic lines, fittings, connections and components for leaks.
- Check tension of drive belts.
- Check windshield washer fluid level.
- Check headlight cleaner fluid level (if equipped).
- Check engine coolant level and specific gravity.
- Check tightness of water hose clamps including heater hoses.
- Check accelerator cable and its linkage for free movement.
- Check choke control and wide open throttle position (12A engine).
- Check sub-zero starting and fluid level (if equipped).
- Check engine oil level.
- Check power steering fluid level (if equipped).
- Check brake and clutch master cylinder fluid level.
- Check steering gear box oil level.
- Check tightness of battery terminals.
- Clean spark plugs.

### INTERIOR

- Install fuses for accessories and check presence of spare fuse.
- Check operation of seat controls and head rest (sliding and reclining).
- Check operation of parking brake.
- Check operation of door lock.
- Check operation of remote control outside rear view mirror (if equipped).
- Check operation of sunroof (if equipped).
- Install rubber stopper for inside rearview mirror.
- Check operation of ignition switch and steering lock.
- Check operation of inhibitor switch (A/T only).
- Check seat belt and warning system.
- Check operation of all warning system.
- Check operation of head light cleaner (if equipped).
- Check operation of cigarette lighter and clock.
- Adjust antenna trimmer on radio and check operation of radio and antenna (if equipped).

### UNDER HOOD-ENGINE RUNNING AT NORMAL OPERATING TEMPERATURE

- Check initial ignition timing.
- Check carburetor float level (12A engine).
- Check idle speed.
- Check throttle sensor.
- Check by-pass air control system (13B engine).
- Check operation of throttle opener for air conditioner and/or power steering (if equipped).
- Check automatic transmission fluid level.

### ON HOIST

- Remove protective cover from brake disc plates.
- Check manual transmission oil level.
- Check rear axle oil level.
- Inspect underside fuel, coolant and hydraulic lines, fittings, connections and components for leaks.
- Check steering linkage, suspension, exhaust system and all underside hardware for looseness and damage.
- Check tires for cuts and bruises.

### ROAD TEST

- Check brake operation.
- Check clutch operation.
- Check steering control.
- Check operation of meters and gauges.
- Check for squeaks, rattles or unusual noise.
- Check general engine performance.
- Check emergency locking retractors.
- Check cruise control system (if equipped).

### AFTER ROAD TEST

- Remove seat and floor mat protective covers.
- Check for necessary owner information materials, tools, and spare tire in vehicle.

47U00X-001

**EXTERIOR**

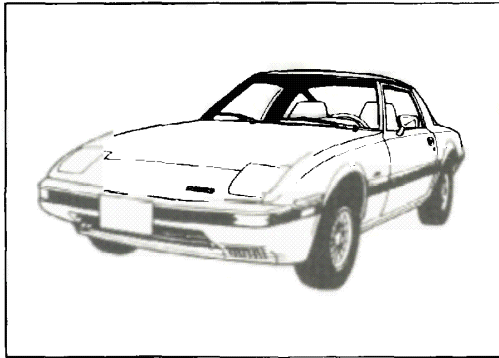

47U00X-002

**CHECKING APPEARANCE**

Inspect glasses, all exterior bright metal surfaces and painted surfaces for damage or rust.

Check all weather strips for damage and detachment.

Install the outside rearview mirror(s).

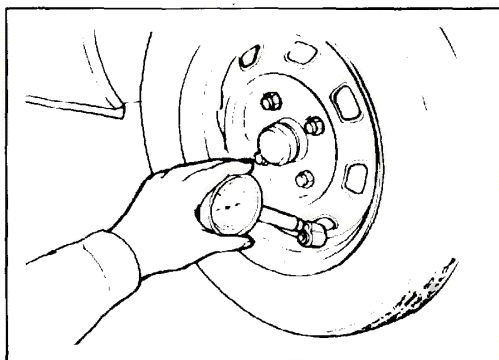

47U00X-003

Tighten the wheel lug nuts to specified torque.

Adjust the tire pressure to specification.

Install the wheel rings or covers (if equipped).

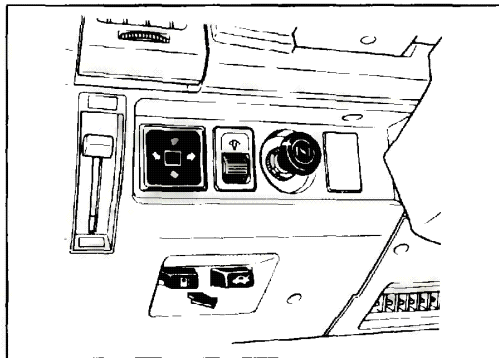

47U00X-004

**CHECKING REMOTE CONTROL**

Check the operation of bonnet release and lock.

Check operation of fuel lid opener.

Check operation of rear glass hatch.

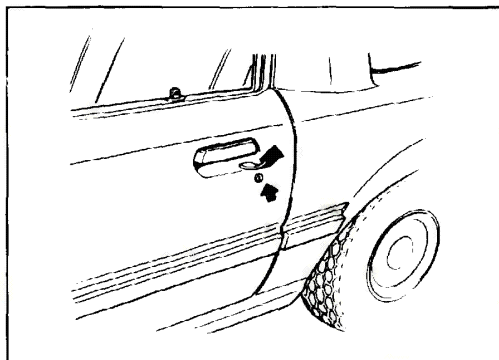

47U00X-005

Check door operation and alignment.

# 0 PRE-DELIVERY INSPECTION

## UNDER HOOD-ENGINE OFF

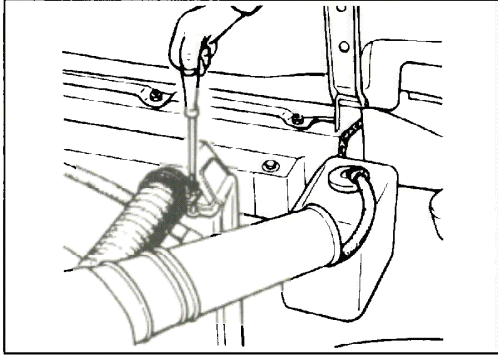

47U00X-006

### CHECKING LEAKS

Inspect the fuel, coolant and hydraulic lines, fittings, connections and components for leaks.

Check the tightness of water hose clamps including heater hoses.

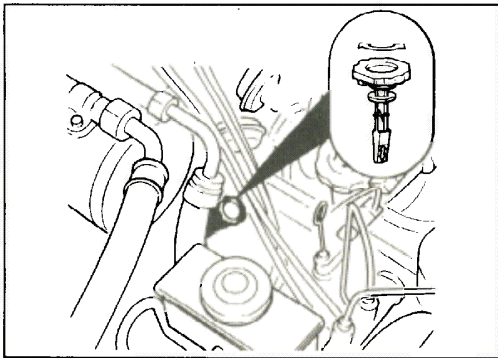

47U00X-007

### CHECKING FLUID LEVELS

Check the power steering fluid level (if equipped).

Check the engine oil level.

Check the brake and clutch master cylinder fluid level.

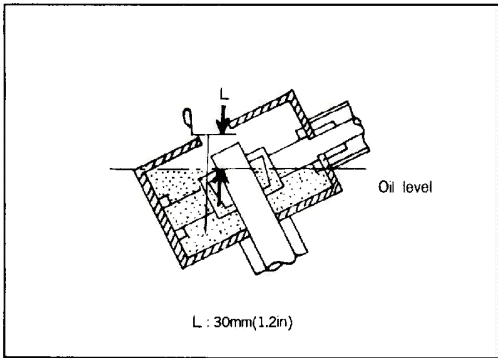

47U00X-008

Check oil level for manual steering gear box.

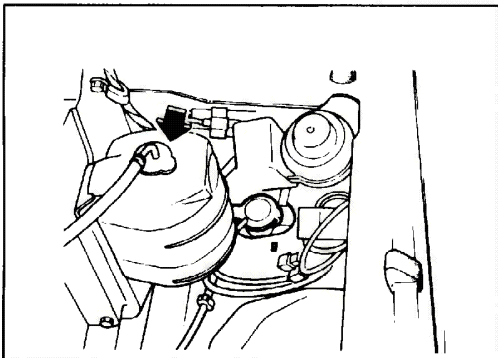

47U00X-009

Check the engine coolant level and specific gravity.

Check the windshield washer fluid level.

Check the tightness of battery terminals.

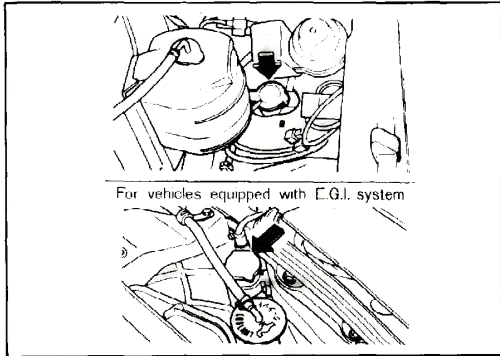

47U00X-010

Check headlight cleaner fluid level (if equipped).

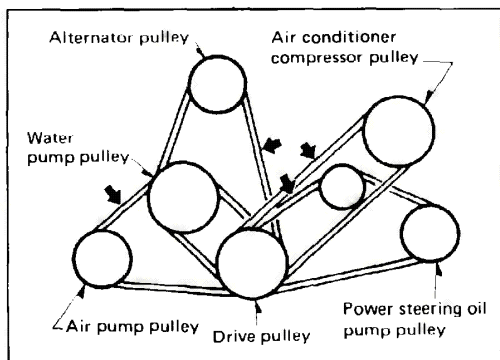

47U00X-011

### CHECKING AND CLEANING

Check the drive belt tension.

#### Belt deflection:

**Alternator: 13 ~ 17 mm (0.51 ~ 0.67 in)**

**Air conditioner: 10 ~ 12 mm (0.39 ~ 0.47 in)**

**Power steering: 10 ~ 12 mm (0.39 ~ 0.47 in)**

Clean the spark plugs.

Check the accelerator cable, carburetor linkages, choke control and wide open throttle position.

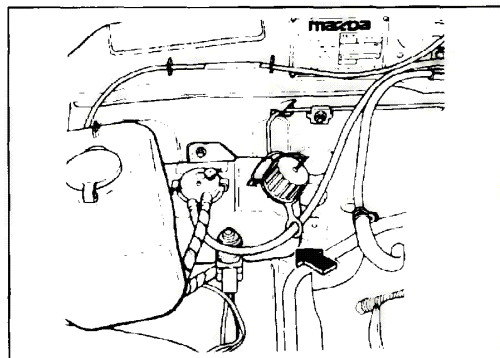

47U00X-012

### CHECKING SUB-ZERO STARTING ASSIST SYSTEM

1. Check the sub-zero starting assist fluid level in the reservoir.
2. Disconnect the connector from the magnet switch on the starting motor.

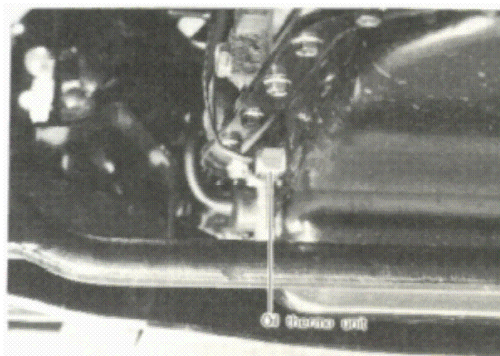

47U00X-013

3. Disconnect the connector from the oil thermo unit on the oil pan and earth the disconnected connector to the body.

4. Turn the ignition key to the "START" position and make sure that the motor of the starting assist fluid operator properly.

# 0 PRE-DELIVERY INSPECTION

## INTERIOR

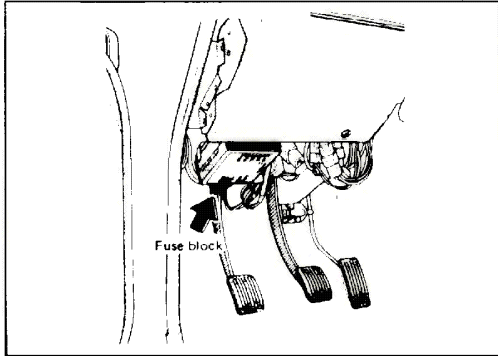

47U00X-014

### CHECKING ELECTRICAL COMPONENTS

Install the fuse for accessories and confirm presence of spare fuses.

Check the seat belts and warning system.

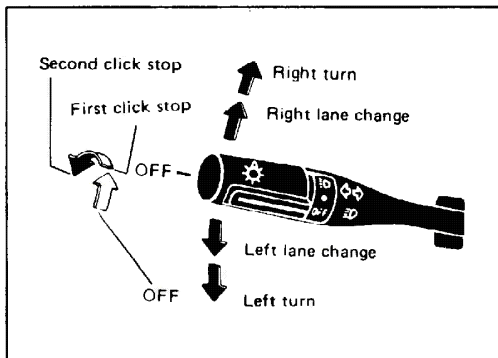

47U00X-015

Check the operation of ignition switch and steering lock.

Check the operation of all lights including warning and indicator lights.

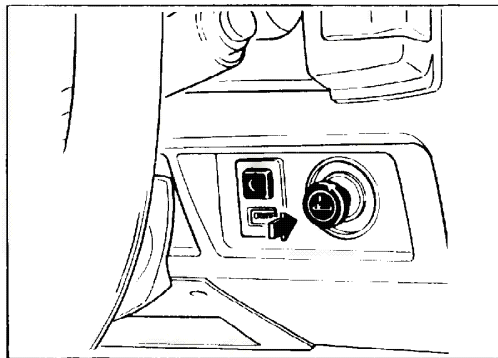

47U00X-016

Check the operation of horn, windshield wipers and washer including rear wiper and washer, if equipped.

Check the operation of cigarette lighter and clock.

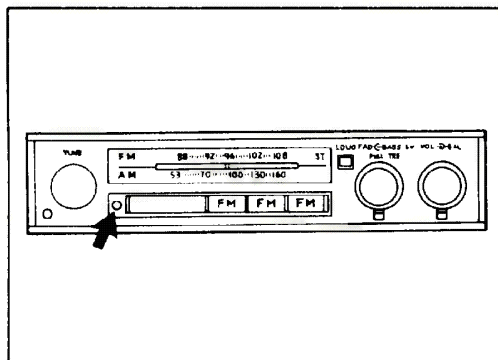

47U00X-017

Adjust the antenna trimmer as described on page 15-66.

Check the operation of radio and antenna.

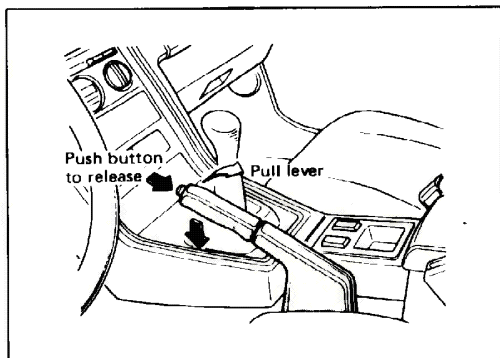

47U00X-018

**CHECKING INTERIOR OPERATION**

Check the operation of seat controls and head rests.

Check the operation of parking brake.

Check the operation of inhibitor switch (automatic transmission only).

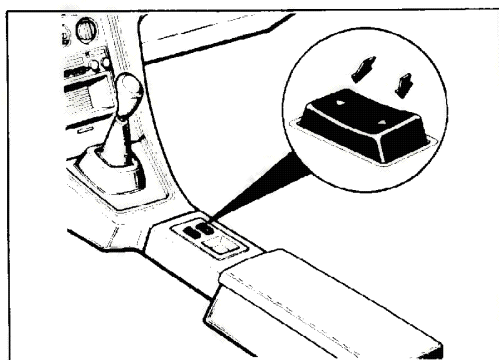

47U00X-019

Check the operation and fit of windows (including power windows if equipped).

Check the operation of door locks.

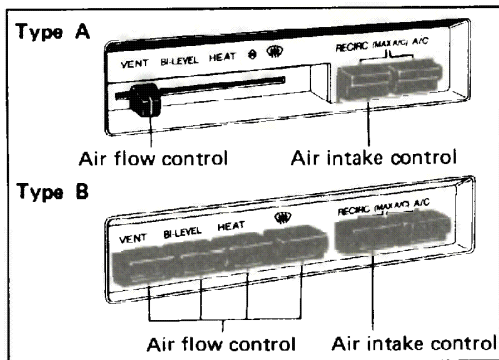

47U00X-020

Check the heater, defroster and air conditioner for proper air flow when various modes are selected (if equipped).

Check the operation of head light cleaner (if equipped).

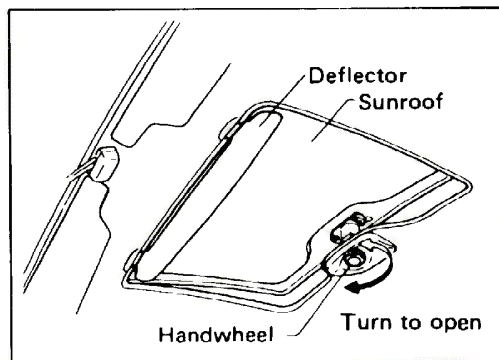

47U00X-021

Check the operation of sunroof (if equipped).

Install the rubber stopper for inside rearview mirror (if equipped).

Inspect upholstery and interior finish.

# 0 PRE-DELIVERY INSPECTION

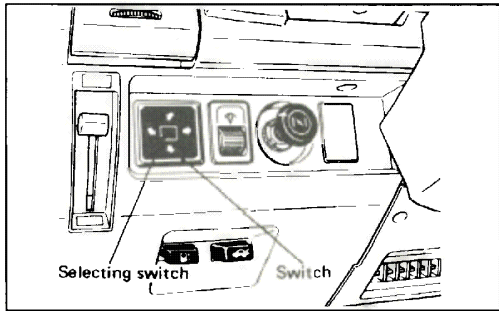

47U00X-022

Check the operation of remote control outside rearview mirror(s) (if so equipped).

## UNDER HOOD-ENGINE RUNNING AT NORMAL OPERATING TEMPERATURE

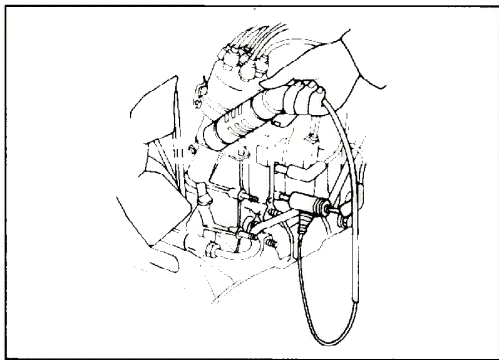

47U00X-023

Check the initial ignition timing.

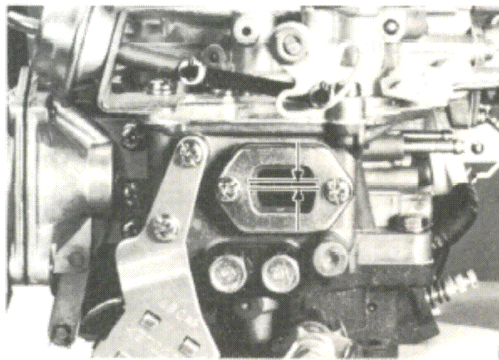

47U00X-024

Check the carburetor float level (12A engine only).

## CHECKING IDLE SPEED

### 12A Engine

1. Set the parking brake and block the wheels.
2. Turn off all accessories and remove the fuel filler cap.
3. Warm-up the engine to the normal operating temperature.
4. Disconnect the tube at the idle compensator in the air cleaner and plug the end of the tube.
5. Check that the dash pot rod and throttle opener (for air conditioner) does not keep the throttle lever from returning to the idle stop.
6. Check the idling speed. If the idling speed is not specified, adjust the idling speed to **750 rpm** by turning the throttle adjust screw.

### Idle speed:

**Manual transmission: 750 rpm in neutral**

**Automatic transmission:**

**750 rpm in "D" position**

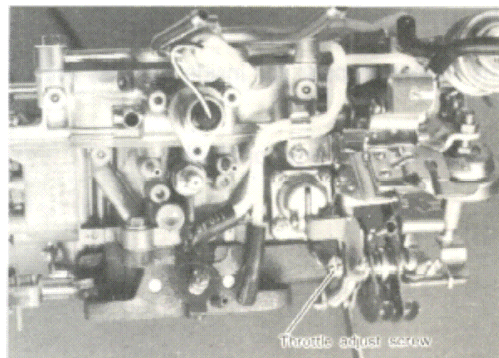

47U00X-025



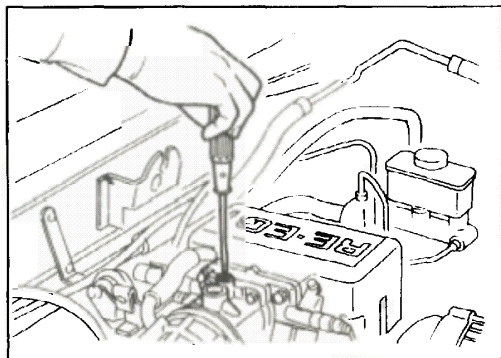

57U00X-026

**13B Engine**

1. Set the parking brake and block the wheels.
2. Turn off all accessories and remove the fuel filler cap.
3. Warm up the engine to the normal operating temperature.
4. Check the throttle sensor as described on page 4B-39.
5. Disconnect the vent and vacuum solenoid valve connector.
6. Check the idling speed. If the idling speed is not specified, adjust the idling speed to 800 rpm by turning the air adjust screw.

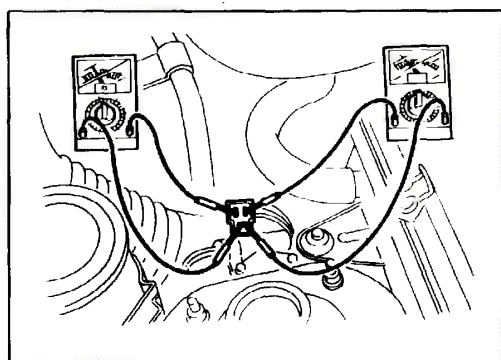

47U00X-027

**CHECKING THROTTLE SENSOR**

**13B Engine**

1. Warm up the engine thoroughly and stop the engine.
2. Connect the voltmeters to checking connector (Green color).
3. Turn the ignition switch to ON position, and make sure that the current flows to one of the voltmeters.
4. If the current flows to both voltmeters or does not flow at all, turn the throttle sensor adjusting screw in or out until the current flows to one of the voltmeters.
5. After adjusting, install the cap onto the adjusting screw.

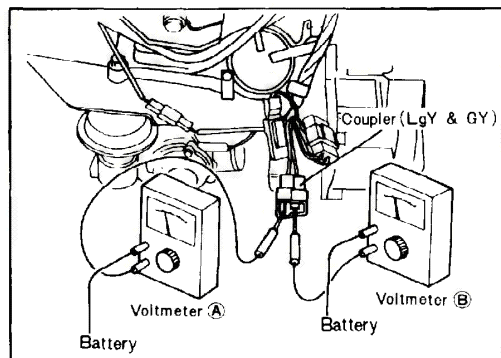

47U00X-028

**12A Engine**

1. Warm the engine to normal operating temperature.
2. Connect a tachometer to the engine.
3. Disconnect connector (BY, GB) as shown in figure.
4. Connect the negative probe of the voltmeter with each terminal (GY and LgY) and connect the positive probe of the battery.
5. Start the engine. Quickly decelerate the engine speed from **3,000 rpm** and make sure that the current flows to each terminal simultaneously. The engine speed should be **1,100 ± 50 rpm**.

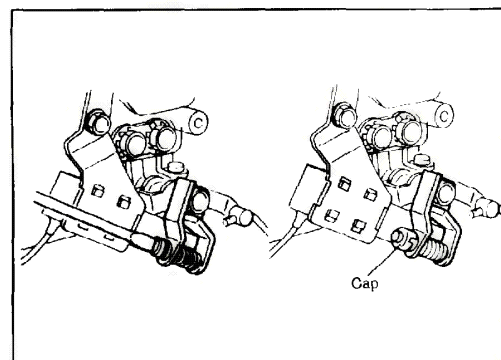

47U00X-029

6. If the current does not start to flow to both terminals simultaneously, remove the cap from the throttle sensor adjusting screw.
7. Adjust the timing of the current flowing to the voltmeter A (LgY) by turning the throttle sensor adjusting screw. When the adjusting screw is screwed in, the current begins to flow earlier, when the adjusting screw is screwed out the current flows later.
8. After adjusting, re-install the cap on the adjusting screw.

## 0 PRE-DELIVERY INSPECTION

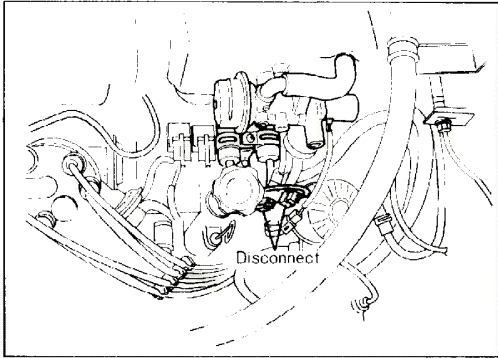

47U00X-030

### CHECKING BY-PASS AIR CONTROL (BAC) SYSTEM (13B ENGINE ONLY)

1. Warm up the engine and run it at idling speed.
2. Turn the headlight switch ON and disconnect the vent and vacuum solenoid valve connector. The engine speed decreases.
3. Connect the vent and vacuum solenoid valve connector and make sure that the engine speed increases to 800 rpm.

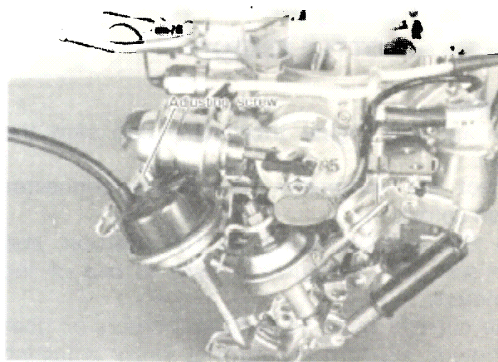

47U00X-031

### CHECKING THROTTLE OPENER FOR AIR CONDITIONER AND POWER STEERING

#### 12A Engine

1. Start the engine and run it at idling speed.
2. Turn ON the air conditioner switch and make sure the engine speed does not drop.
3. On the vehicle equipped with power steering, turn the steering wheel to either the right or left lock position and make sure that the magnetic clutch of the compressor turn off.

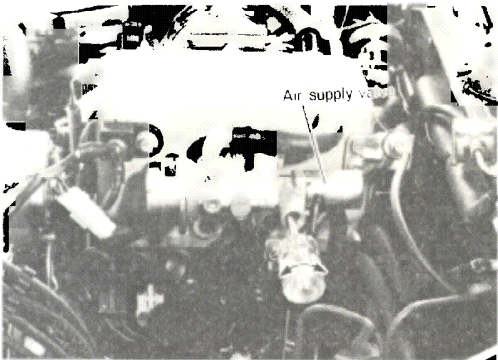

47U00X-032

#### 13B Engine

1. Start the engine and run it at idling speed.
2. Turn ON the air conditioner switch and make sure the engine speed does not drop.
3. On the vehicle equipped with power steering, turn the steering wheel to either the right or left lock position, and make sure that the magnetic clutch of the compressor turns off.

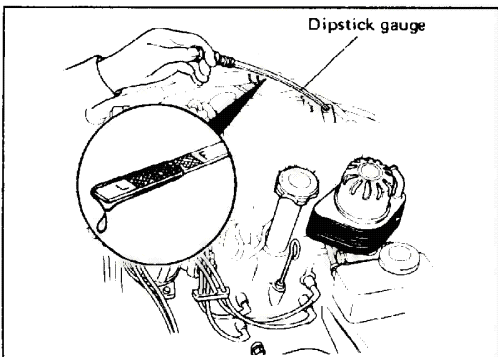

47U00X-033

Check the automatic transmission fluid level.

**ON HOIST**

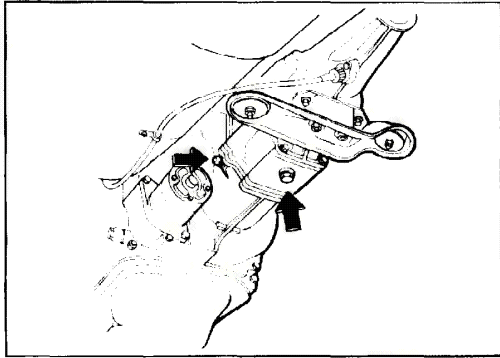

47U00X-034

Check the manual transmission oil level.

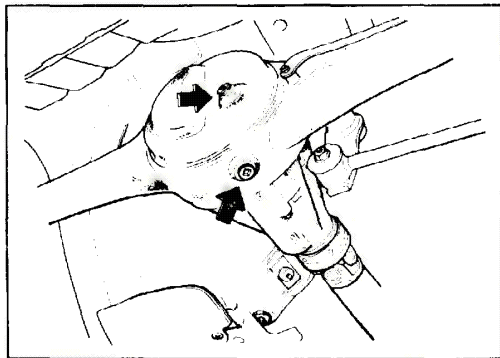

47U00X-035

Check the rear axle oil level.

Inspect the fuel, coolant and hydraulic lines, fittings, connections and components for leaks.

Check the tires for cuts and bruises.

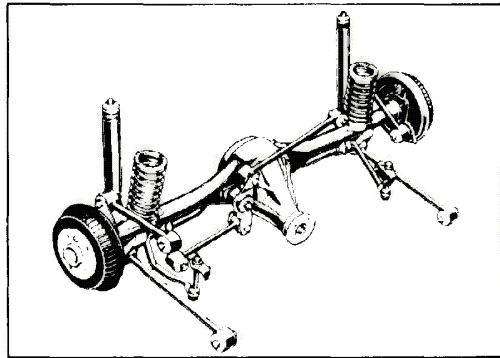

47U00X-036

Check the steering linkage, suspension, exhaust system and all underbody hardware for looseness or damage.

**ROAD TEST**

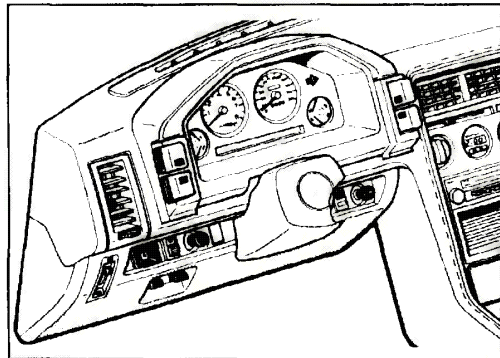

47U00X-037

Check the brake operation.

Check the clutch operation.

Check the steering control.

Check operation of meters and gauges.

## 0 PRE-DELIVERY INSPECTION

---

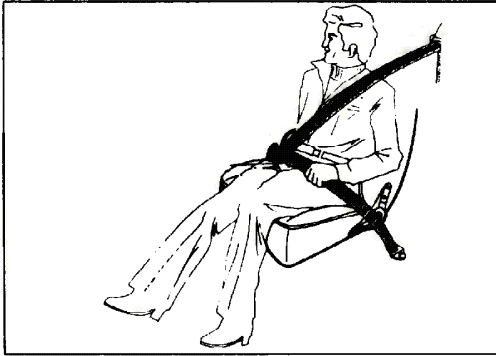

47U00X-038

### AFTER ROAD TEST

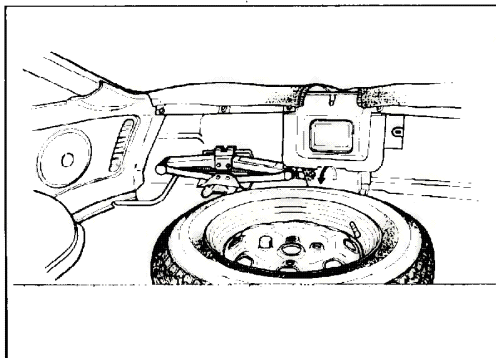

47U00X-039

Check for squeaks, rattles, or other unusual noise.

Check the engine general performance.

Check the emergency locking retractors.

Check the cruise control system (if equipped).

Remove the seat and floor mat protective covers.

Check for necessary owner information materials, tools, and spare tire in vehicle.

# SCHEDULED MAINTENANCE

MAINTENANCE TABLE – 1

Main-tenance items	Maintenance intervals	Number of months or miles, whichever comes first										Reference page
		Months	—	7.5	15	22.5	30	37.5	45	52.5	60	
		x 1000 miles	2,000	7,500	15,000	22,500	30,000	37,500	45,000	52,500	60,000	

## ENGINE

Engine oil *1	R	R	R	R	R	R	R	R	R	R	0-15
Oil filter *1			R		R		R			R	0-15
Drive belts (except air pump drive belt)						I				I	0-15
Choke system (except for EGI)			I*3			I		I*3		I	0-16

## AIR CLEANER

Air cleaner element *2						R				R	0-16
------------------------	--	--	--	--	--	---	--	--	--	---	------

## IGNITION SYSTEM

Spark plugs			I*4			R		I*4		R	0-16
-------------	--	--	-----	--	--	---	--	-----	--	---	------

## COOLING SYSTEM

Cooling system			I			I		I		I	0-16
Engine coolant						R				R	0-17

## FUEL SYSTEM

Idle speed			I*5			I*5		I*5		I	0-17
Fuel filter						R*4				R	0-18

## ELECTRICAL SYSTEM

Engine oil level warning system			I			I		I		I	0-18
Engine coolant level warning system						I				I	0-19
Sub-zero starting assist system	Check operation seasonally										0-19

## CHASSIS AND BODY

Clutch pedal			I			I		I		I	0-20
Clutch fluid						I				I	0-20
Brake lines, hoses and connections			I			I		I		I	0-20
Brake pedal			I			I		I		I	0-20
Brake fluid *6			I			R		I		R	0-21
Parking brake			I			I		I		I	0-21

47U00X 040

### Chart symbol:

- I : Inspect, and if necessary correct, clean or replace.
- A : Adjust
- R : Replace or change
- L : Lubricate
- T : Tighten

# 0 SCHEDULED MAINTENANCE

MAINTENANCE TABLE – 2

Main-tenance items	Maintenance intervals	Number of months or miles, whichever comes first									Reference page	
		Months	—	7.5	15	22.5	30	37.5	45	52.5		60
		x 1000 miles	2,000	7,500	15,000	22,500	30,000	37,500	45,000	52,500		60,000
Power brake unit and hoses						I				I	0-21	
Disc brakes			I	I	I	I	I	I	I	I	0-21	
Drum brakes				I		I		I		I	0-22	
Power steering fluid and lines (if equipped)				I		I		I		I	0-22	
Checking manual steering gear oil level				I		I		I		I	0-22	
Steering operations and gear housing				I		I		I		I	0-22	
Steering linkages, tie rod ends and arms				I		I		I		I	0-23	
Front suspension ball joints						I				I	0-23	
Front wheel bearings						L				L	0-23	
Manual transmission oil						R				R	0-23	
Automatic transmission fluid level			I			I				I	0-24	
Rear axle oil			I			R				R	0-24	
Bolts and nuts on chassis and body				T		T		T		T	0-24	
Exhaust system heat shield						I				I	0-24	
Seat belts, buckles, retractors and anchors				I		I		I		I	0-25	

47U00X-041

- Remarks:**
1. After 60,000 miles or 60 months, continue to follow the described maintenance intervals.
  2. As for \*marked items in this maintenance table, please pay attention to the following points.
    - \*1 If the vehicle is operated under the following conditions, it is suggested that the engine oil and oil filter be changed more frequently.
      - a) Driving in dusty conditions
      - b) Extended periods of idling or low speed condition
      - c) Driving for a prolong period in cold temperature or driving short distances only.
    - \*2 If the vehicle is operated in very dusty or sandy areas, replace more often than at usual recommended intervals.
    - \*3 Except for California vehicles.
    - \*4 Vehicles except for California, this maintenance operation is recommended by Mazda.
    - \*5 This maintenance operation is recommended by Mazda.
    - \*6 Where there has been continuous hard driving, mountain driving, or where the brakes are used extensively or the vehicle is operated in extremely humid climates, the brake fluid should be changed annually.

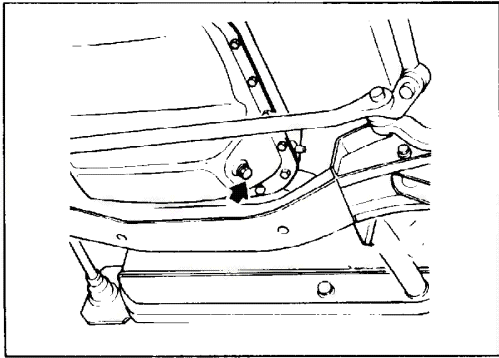

39G00X-005

**REPLACING ENGINE OIL**

1. Warm up the engine if it is cold.
2. Remove the oil filler cap to allow the oil to drain easily.
3. Fill engine oil to the "F" mark on the dipstick. Use oil with the proper SAE viscosity.

**Note**

After starting the engine, recheck the oil level and also check the drain plug washer for leaks whenever it is replaced.

Typical specification: API service SD, SE or SF

**Recommended SAE viscosity numbers**

Temperature (°C)	-30	-20	-10	0	10	20	30	40	50	
Temperature (°F)	-20	0	20	40	60	80	100	120		
Engine oil										

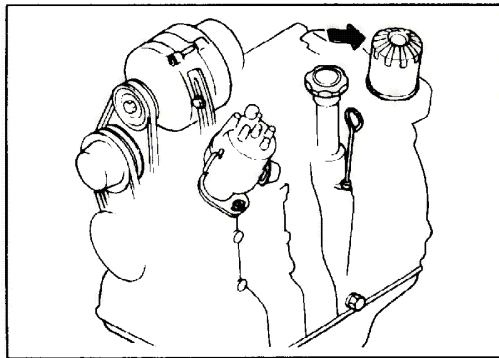
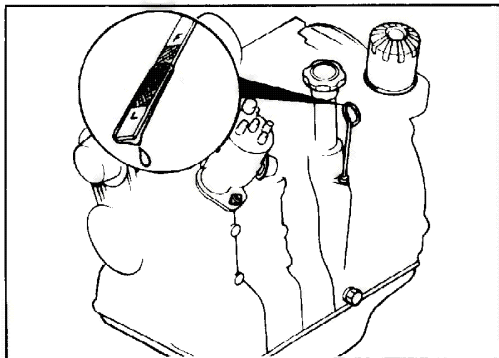

47U00X-042

**REPLACING ENGINE OIL FILTER**

To install the oil filter, apply engine oil to the oil filter gasket, and then tighten the oil filter fully by hand.

**On 12A Engine Only**

After tightening the oil filter fully by hand, tighten it further 1/8 turn with a band-type wrench. Do not use chain-type filter wrench.

**Caution**

After installing the filter, start the engine and check that the joints are not leaking. Top up with oil if necessary.

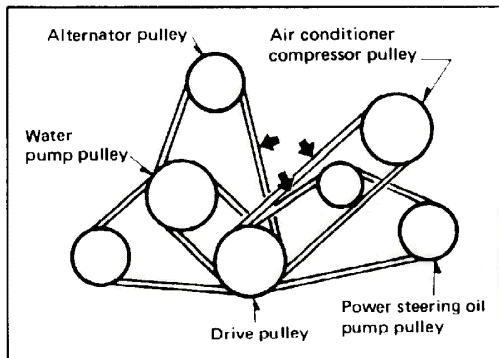

47U00X-043

**CHECKING DRIVE BELT**

1. Check the belt for cracks or any other damage.
2. If necessary, adjust the drive belt tension with thumb pressure of about 10 kg (22 lb).

**Belt deflection**

- Alternator drive belt: 13 ~ 17 mm (0.51 ~ 0.67 in)
- Air conditioner drive belt: 10 ~ 12 mm (0.40 ~ 0.47 in)
- Power steering drive belt: 10 ~ 12 mm (0.40 ~ 0.47 in)

## 0 SCHEDULED MAINTENANCE

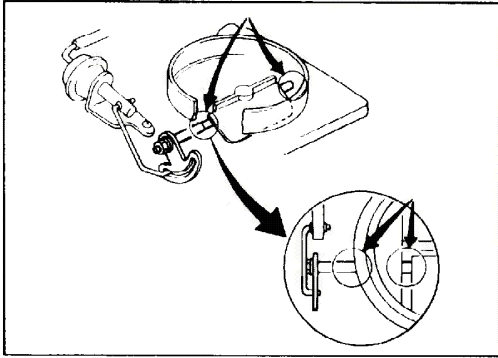

47U00X-044

### CLEANING CHOKE SYSTEM

To clean the choke linkage, use cleaning agent such as Carb Spray Cleaner or equivalent for cleaning.

1. Spray cleaning agent on choke linkage to remove dirt or grease.
2. Spray cleaning agent on both ends of choke shaft while moving the choke valve slowly by hand.
3. Use compressed air to dry the sprayed areas.
4. Apply spray lubricant and move choke lever several times to check the free movement of choke mechanism.

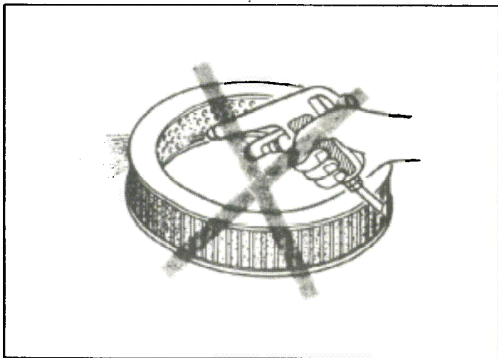

39G00X-011

### REPLACING AIR CLEANER ELEMENT

Use only a Mazda genuine air cleaner element or one of equivalent quality.

#### Caution

**Do not blow the element with compressed air.**

### CHECKING SPARK PLUGS

1. Check the plugs for burned or eroded electrodes, fouling, or cracked porcelain.
2. Measure the electrode gap. If necessary, replace the spark plugs.

**Plug gap:  $1.4 \pm 0.05$  mm ( $0.055 \pm 0.002$  in)**

**Recommended spark plugs:**

**NGK: BR7EQ14, BR8EQ14, BR9EQ14**

**NIPPON DENSO:**

**W22EDR14, W25EDR14, W27EDR14**

#### Cautions

- a) When installing a new plug or reinstalling old plugs, use a small amount of anti-seize compound or molybdenum-based thread lubricant on the first few threads.
- b) Do not pull the spark plug cables to remove them.

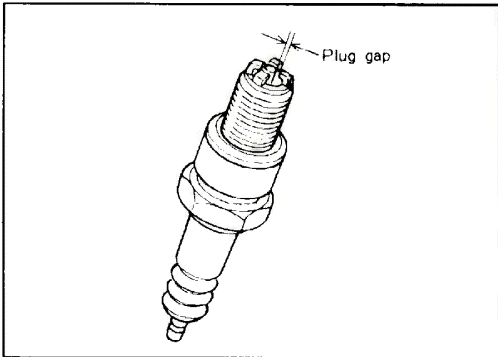

47U00X-045

### CHECKING COOLING SYSTEM

1. Check the cooling system hoses (including the heater hoses) for cracks or wear.
2. Check the cooling system for leaks by applying a pressure of  $1.05$  kg/cm<sup>2</sup> ( $15.13$  lb/in<sup>2</sup>) with a radiator cap tester.

#### Note

**Do not pressurize the system to more than  $1.05$  kg/cm<sup>2</sup> ( $15.13$  lb/in<sup>2</sup>).**

If necessary, replace the hoses.

#### Warning

**Be careful to avoid injury from escaping steam or hot water when removing the radiator cap.**

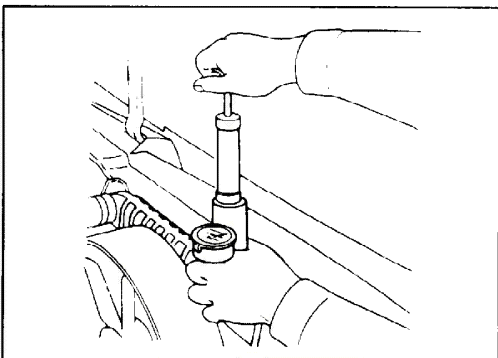

39G00X-007



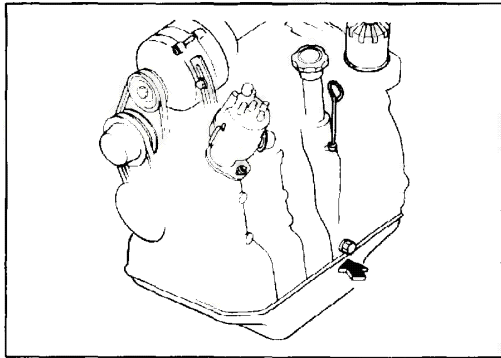

47U00X-046

**REPLACING ENGINE COOLANT**

Drain the engine coolant by removing the radiator drain plug.

**Warning**

**Be careful to avoid injury when checking a hot engine.**

Fill with new coolant according to the recommended mixture ratio as follows.

Protection	Mixture percentage (by volume)	
	Anti-freeze	Water
Above -16°C (3°F)	35	65
Above -26°C (-15°F)	45	55
Above -40°C (-40°F)	55	45

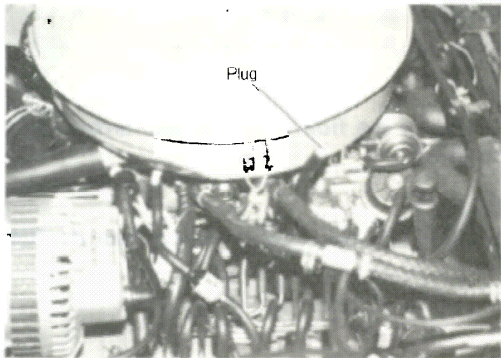

47700X-047

**CHECKING IDLE SPEED**

**12A Engine**

1. Set the parking brake and block the wheels.
2. Turn off all accessories and remove the fuel filler cap.
3. Warm-up the engine to the normal operating temperature.
4. Disconnect the tube at the idle compensator in the air cleaner and plug the end of the tube.
5. Check that the dash pot rod and throttle opener (for air conditioner) does not keep the throttle lever from returning to the idle stop.
6. Check the idling speed. If the idling speed is not specified, adjust the idling speed to **750 rpm** by turning the throttle adjust screw.

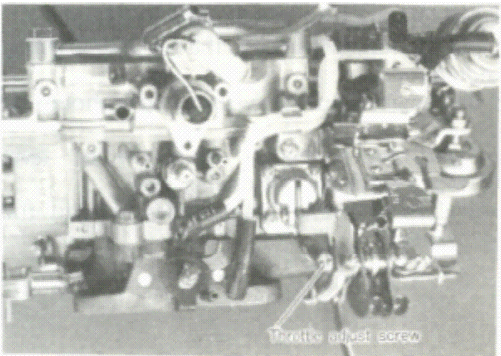

47U00X-048

**Idle Speed:**

**Manual transmission: 750 rpm in neutral**

**Automatic transmission:**

**750 rpm in "D" position**

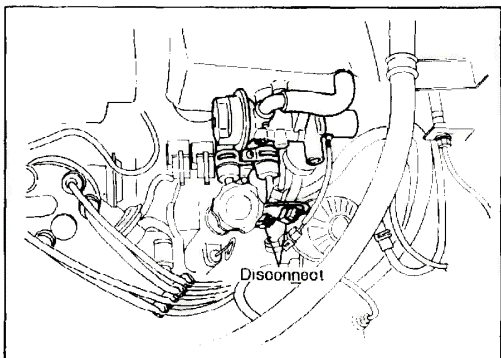

47U00X-049

**13B Engine**

1. Set the parking brake and block the wheels.
2. Turn off all accessories and remove the fuel filler cap.
3. Warm-up the engine to the normal operating temperature.
4. Check the throttle sensor as described on page 4B-39.
5. Disconnect the vent and vacuum solenoid valve connector.

## 0 SCHEDULED MAINTENANCE

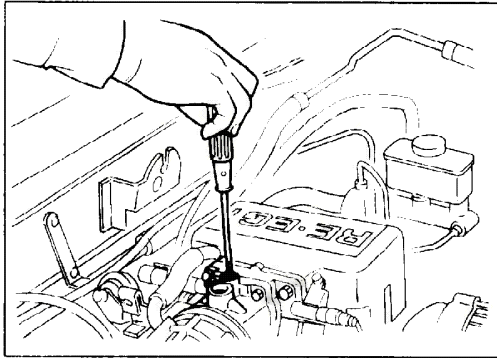

57U00X-050

6. Check the idling speed. If the idle speed is not specified, adjust the idling speed to 800 rpm by turning the air adjust screw.

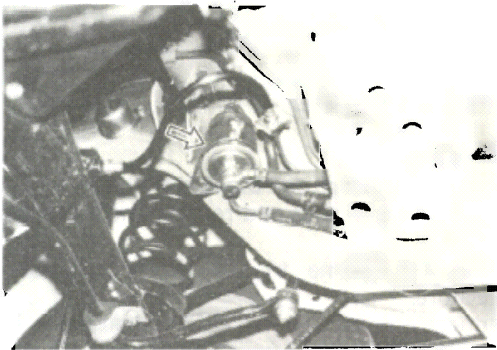

39G00X-009

### REPLACING FUEL FILTER

Replace the fuel filter with a new one.

#### Note

Be careful of the flow direction and arrow mark on the filter.

#### Warning

Keep sparks and open flames away from the fuel area.

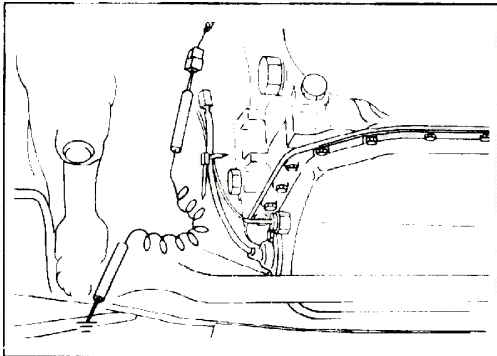

47U00X-051

### CHECKING OIL LEVEL WARNING SYSTEM

1. Turn the ignition switch on, the oil level warning light comes on.
2. Start the engine and the warning light should go off.
3. Disconnect the connector from the oil level sensor and ground the terminal at idle. The oil level warning light comes on and the chime is sound.

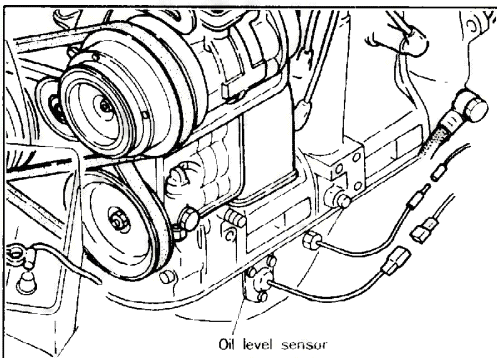

47U00X-052

4. Remove the sensor.
5. Check that the oil holes of the oil chamber are not clogged. If necessary, clean the oil holes with solvent.
6. Connect an ohmmeter to the level sensor and check the continuity by moving the float up and down. When the float is on the upper side, the ohmmeter should not show any continuity. When moved to the lower side, it should show a continuity of the circuit. If it is found not to be so, replace the oil level sensor.

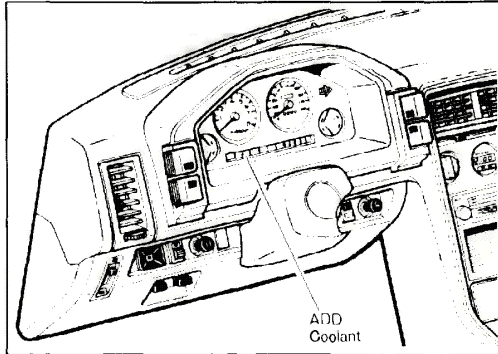

47U00X-053

**CHECKING ENGINE COOLANT LEVEL WARNING SYSTEM**

1. Turn the ignition switch on.  
The coolant level warning light comes on.
2. Start the engine and the warning light should go off.
3. Disconnect the connector from the level sensor and make sure the warning light comes on and chime is sound at idle.

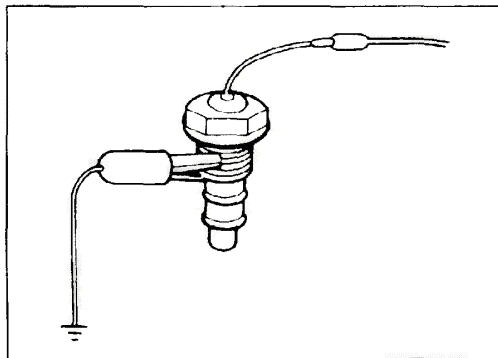

47U00X-054

4. Remove the radiator cap to relieve the pressure in the radiator.
5. Remove the sensor from the radiator and plug the hole to prevent coolant leakage.
6. Carefully check the sensor for cracks or damage.
7. Start the engine.
8. Ground the threaded portion of the sensor.  
Check to see if the coolant level warning light illuminates.  
If it does not, replace the sensor.

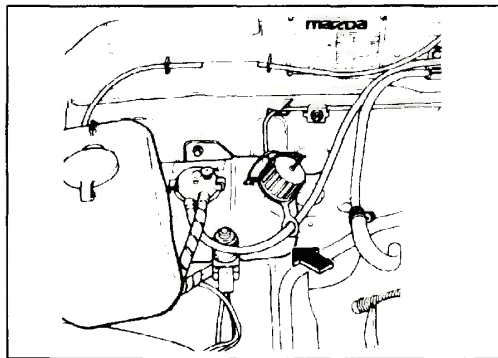

47U00X-055

**CHECKING SUB-ZERO STARTING ASSIST SYSTEM**

1. Check the sub-zero starting assist fluid level in the reservoir.
2. Disconnect the connector from the magnet switch on the starting motor.
3. On the 13B engine, remove the dynamic chamber then the starting fluid valve.

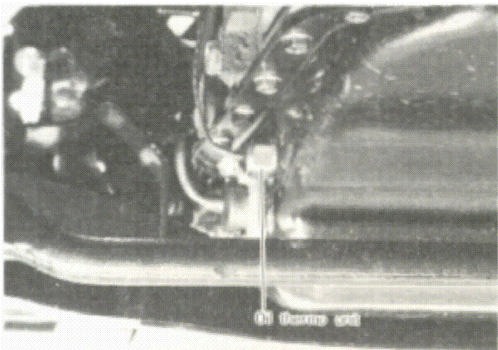

47U00X-056

4. Disconnect the connector from the oil thermo unit on the oil pan and earth the disconnected connector to the body.
5. Turn the ignition key to the "START" position with the air bleeding button of the tank kept pushed and make sure that the starting assist fluid spouts out from the nozzle on the 12A engine or starting fluid valve on 13B engine.

## 0 SCHEDULED MAINTENANCE

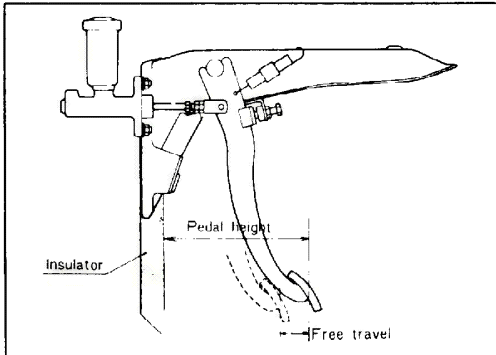

39G00X-026

### CHECKING CLUTCH PEDAL

1. Check the pedal for smooth operation.
2. Check the pedal height. If necessary, adjust the pedal height by turning the stopper bolt. Then, tighten lock nut.
3. Check the pedal free play. If necessary, adjust the pedal free play by turning the push rod. Then, tighten lock nut.

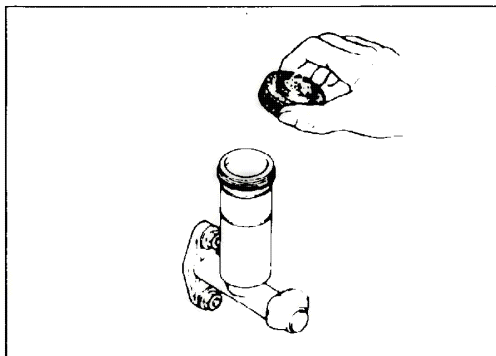

39G00X-027

### CHECKING CLUTCH FLUID

Check that clutch fluid level is near the upper level line on the reservoir. If necessary, add the fluid to bring the level to upper level line.

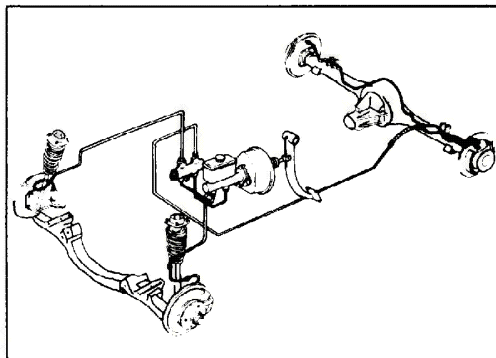

39G00X-028

### CHECKING BRAKE LINE, HOSE AND CONNECTIONS

Check the brake lines and hoses for proper attachment and connections. There should not be leaks, cracks, chafing, abrasion, deterioration, etc. on lines and connections.

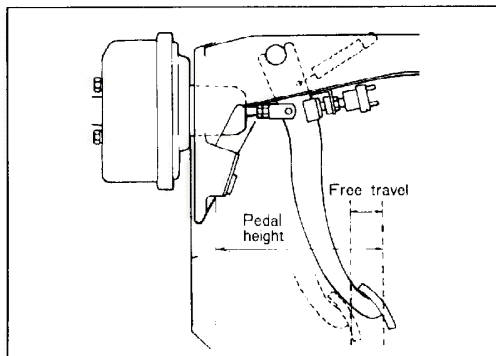

47U00X-057

### CHECKING BRAKE PEDAL

1. Check the pedal for smooth operation.
2. Check the pedal height. If necessary, adjust the pedal height by turning the stop switch. Then, tighten lock nut.
3. Check the pedal free play. If necessary, adjust the pedal free play by turning the push rod. Then, tighten lock nut.

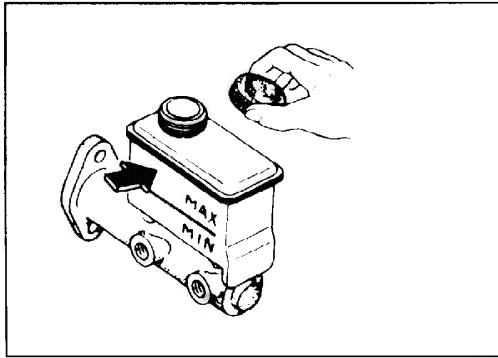

39G00X-030

**CHECKING BRAKE FLUID**

Check that the brake fluid level is near the "MAX" level line on the see-through reservoir. If necessary, add the brake fluid to bring the level at "MAX" level line.

**Fluid specification:**

**DOT-3 or DOT-4 (FMVSS 116)**

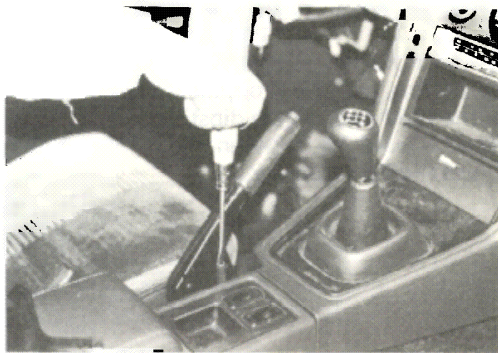

39G00X-031

**CHECKING PARKING BRAKE**

1. Pull the brake lever with 10 kg (22 lb) of force and measure the lever stroke.
2. If necessary, adjust the lever stroke by turning the adjusting nut.

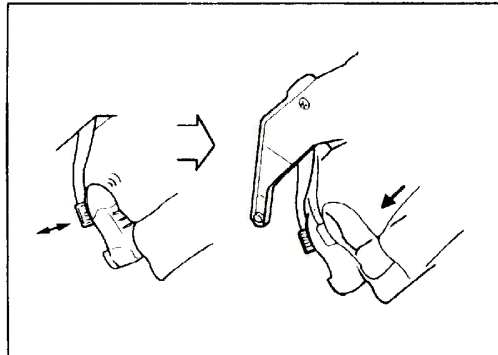

39G00X-032

**CHECKING POWER BRAKE UNIT AND HOSES**

1. Check the vacuum hoses, connectors and check valve for cracks, chafing, deterioration, etc.
2. Check the power brake for proper operation. To check, depress the brake pedal several times to make sure the pedal travel does not change. Then, while depressing brake pedal, start the engine. At this time, the pedal should go down a little.

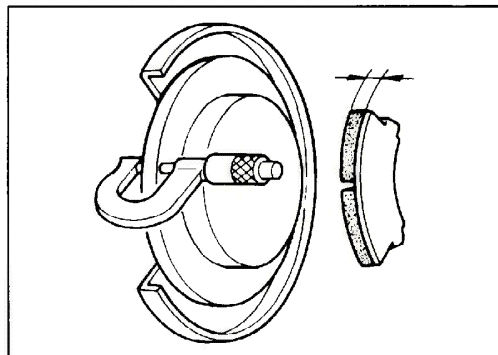

39G00X-033

**CHECKING DISC BRAKE**

Check the following condition of disc brake components.

1. Check caliper operation and inspect for leaks.
2. Check pads for wear.
3. Check condition and thickness of disc plate.

## 0 SCHEDULED MAINTENANCE

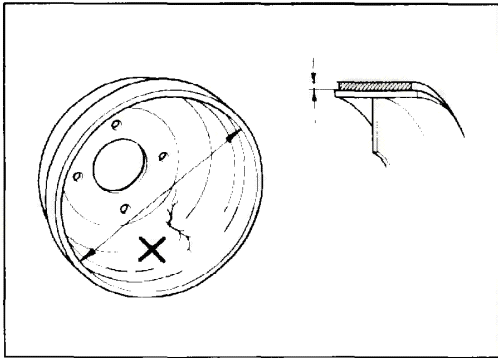

39G00X-034

### CHECKING DRUM BRAKE

Check the following condition of brake drum and linings.

1. Check the wheel cylinder operation and inspect for leaks.
2. Check linings for wear or damage.
3. Check condition of inner surface and inner diameter of drum.

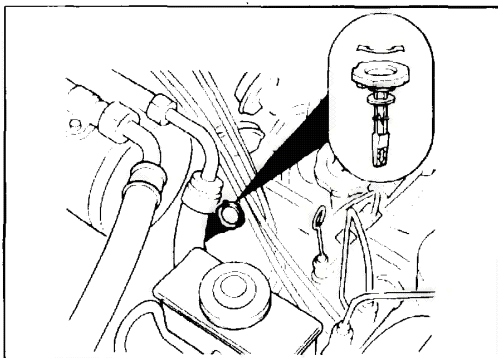

39G00X-035

### CHECKING POWER STEERING FLUID AND LINES

1. Check the fluid hoses, lines and connection for cracks, chafing, deterioration, etc.
2. Check the fluid level on the dipstick.  
The level should be between the "F" and "L" level. Add fluid if necessary.

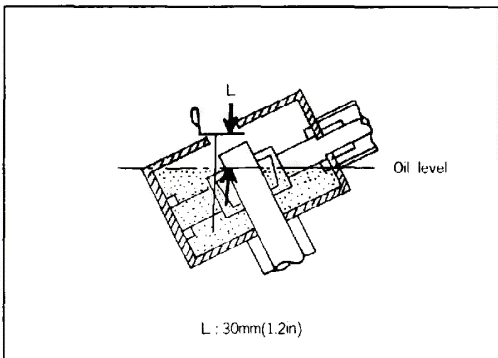

L : 30mm(1.2in)

47U00X-058

### CHECKING MANUAL STEERING GEAR OIL LEVEL

1. Prepare a simple dipstick with a wire.
2. Insert the dipstick to the oil filler hole.
3. Pull out the gauge and measure the dimension "L". If the oil level is not high enough, add the specified gear oil.

#### Specified gear oil:

API service GL-4

Viscosity: SAE 90.

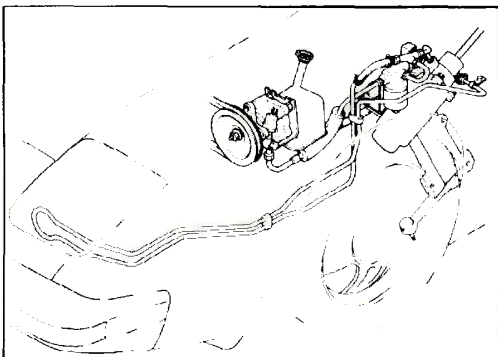

47U00X-059

### CHECKING STEERING OPERATIONS AND GEAR HOUSING

1. Check the steering wheel free play.
2. Check the steering for proper operation and looseness of steering housing.
3. Check the steering gear housing for fluid leakage or oozing.

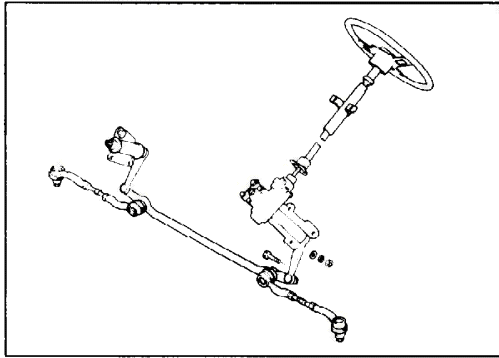

47U00X-060

**CHECKING STEERING LINKAGES, TIE ROD ENDS AND ARMS**

Check the steering linkage for looseness and damage. Check that the;

1. No excessive play on tie rod ends and rack guide
2. No damage on dust boots
3. No looseness or grease leakage on tie rod ends

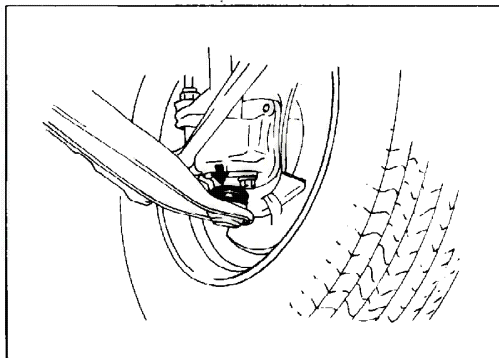

39G00X-038

**CHECKING SUSPENSION BALL JOINT**

Check the ball joints for damage, looseness and grease leakage.

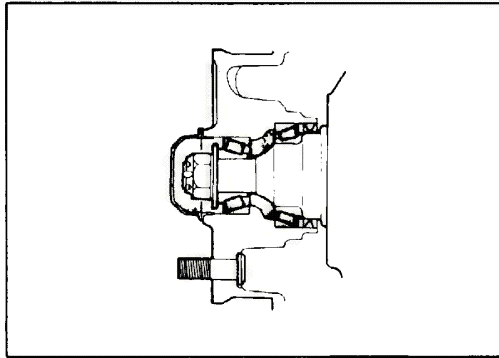

39G00X-039

**LUBRICATING FRONT WHEEL BEARINGS**

1. Remove the hub and inner and outer bearings. Clean in solvent and inspect the bearings for damage.
2. Repack the lithium grease (lithium base, NLGI No. 2) to the following parts.
  - 1) All rolling surfaces of the bearings
  - 2) Between bearing and oil seal
  - 3) Oil seal lip (Replace oil seal with a new ones.)
  - 4) Threaded portion of spindle
  - 5) Hub cap

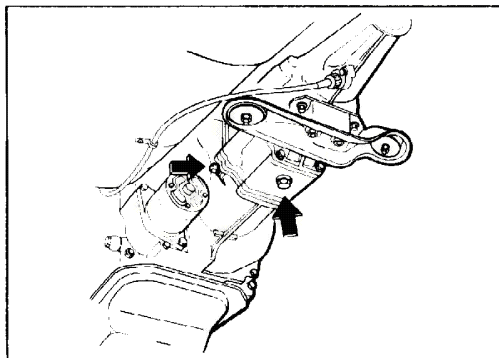

47U00X-061

**REPLACING MANUAL TRANSMISSION OIL**

1. Visually check the transmission oil leakage. If leakage is found, check for cause and repair.
2. Remove the plug and check that the oil comes to the bottom edge of the hole.

**Oil grade: API GL-4 or GL-5**  
**Viscosity: SAE 90 or 80W-90**

## 0 SCHEDULED MAINTENANCE

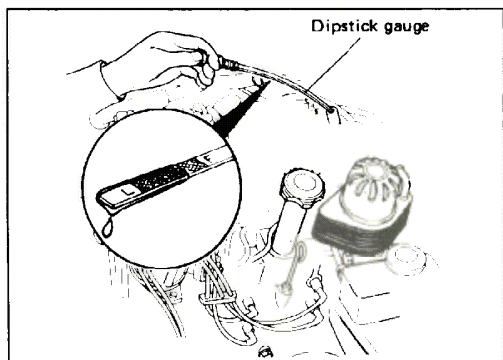

47U00X-062

### CHECKING AUTOMATIC TRANSMISSION FLUID LEVEL

1. Park the vehicle on level ground and set the parking brake firmly.
2. Idle the engine for about two minutes.
3. Move the selector lever through all of the gear positions and set it in the "P" position.
4. Check the level, it should be between the "L" and "F" marks on the dipstick.
5. If necessary, add the specified fluid through the filler tube. Do not overfill.

**Recommended specification:**  
**ATF TYPE F (M2C 33-F)**

### REAR AXLE OIL

Checking or Replacing rear axle oil

1. Visually check the rear axle oil leakage. If leakage is found, check for cause and repair.
2. Remove the plug and check that the oil comes to the bottom edge of the hole.

**Oil grade: API GL-5**  
**Viscosity: Above-18°C (0°F) SAE 90**  
**Below-18°C (0°F) SAE 80W**

On the vehicle equipped with limited – slip differential, it required **API GL-5, SAE 90 special lubricant for limited – slip differentials.**

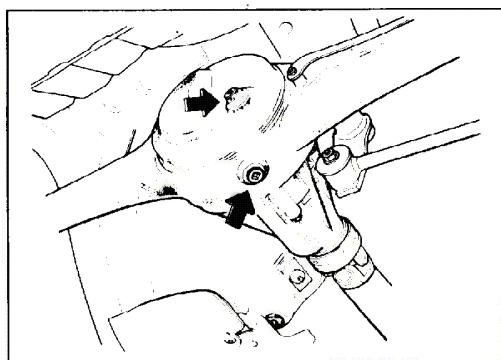

39G00X-041

### TIGHTENING BOLTS AND NUTS ON CHASSIS AND BODY

1. Tighten all seat mounting bolts.
2. Retighten all loose nuts and bolts of front and rear suspensions to the specified torque. (Refer to Section 22.)

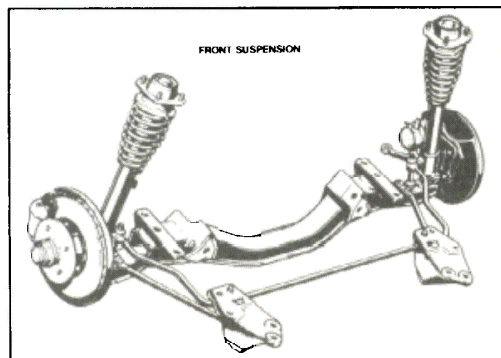

39G00X-042

### CHECKING EXHAUST SYSTEM HEAT SHIELDS

1. Check the clearance between insulator and body, and also between the insulator and the exhaust system.
2. Visually inspect the pipes, hangers and connections for severe corrosion, leaks or damage.

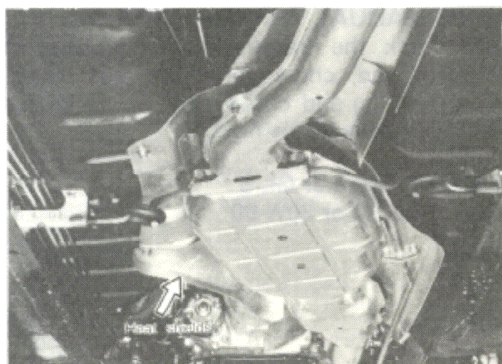

47U00X-063



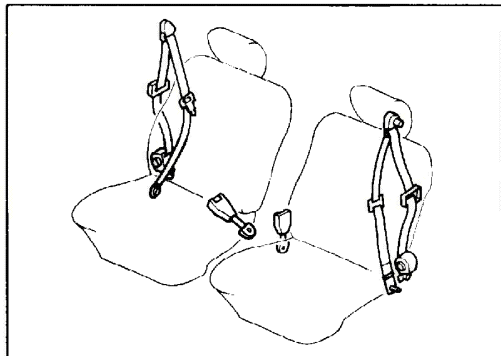

47U00X-064

**CHECKING SEAT BELTS, BUCKLES,  
RETRACTORS AND ANCHORS**

1. Pull each seat belt to be sure it moves smoothly.
2. Check for scratches, tears, or wear of the webbing, and for bent metal fittings.

**Caution**

**Do not disassemble the buckle or ELR assembly.**

3. Check operation of retractors.
4. Check tightness of belt anchor bolts.

**Anchor bolt tightening torque:**

**39 ~ 55 N-m (28.2 ~ 39.8 ft-lb)**